



# GENUINE ROOF RACK

## INSTALLATION AND USER'S INSTRUCTIONS

Thank you for purchasing a genuine Mazda accessory.  
Before removal and installation, be sure to thoroughly read these instructions.  
Please read the contents of this booklet in order to properly install and use the roof rack.  
Your safety depends on it. Keep these instructions with your vehicle records for future reference.

### **WARNING**

- There are several  **WARNING** and  **CAUTION** sections in this booklet concerning safety when installing or removing the roof rack. Always read and follow them in order to prevent injuries, accidents, and possible damage to the vehicle.

 **WARNING** : Indicates a situation in which serious injury or death could result if the warning is ignored.

 **CAUTION** : Indicates a situation in which bodily injury or damage to the vehicle could result if the caution is ignored.

- For areas indicating the tightening torque in this instruction manual, tighten to the specified torque using a torque wrench. For areas in which the tightening torque is indicated inside parentheses ( ), the tightening torque is indicated as a reference value, however tightening using a torque wrench is not necessary.
- Do not modify the roof rack.
- Do not install the roof rack in any way other than described in the following instructions.
- If in any doubt, please ask your Mazda dealer to install the accessory in order to prevent errors in installation.
- If you have any questions about the use of the accessory, ask your Mazda dealer for proper advice before using it.
- Mazda and its suppliers are not responsible for injuries, accidents, and damage to persons and property that arise from the failure of the dealer or installer to follow these instructions.
- To ensure safety and reliability of the work, installation, removal and disposal work must be carried out by an Authorized Mazda Dealership.
- Be careful not to lose removed parts and be sure that they are kept free from scratches, grease or other dirt.

**PART NAME:**            **ROOF RACK**  
**PART NUMBER:**    **BDEL V3 840 (SEDAN)**  
                                 **BDEN V3 840 (HATCHBACK)**  
**VEHICLE:**             **MAZDA 3**

### NOTE

#### To the dealer

- Please turn over these instructions to the customer after installation.

#### To the customer

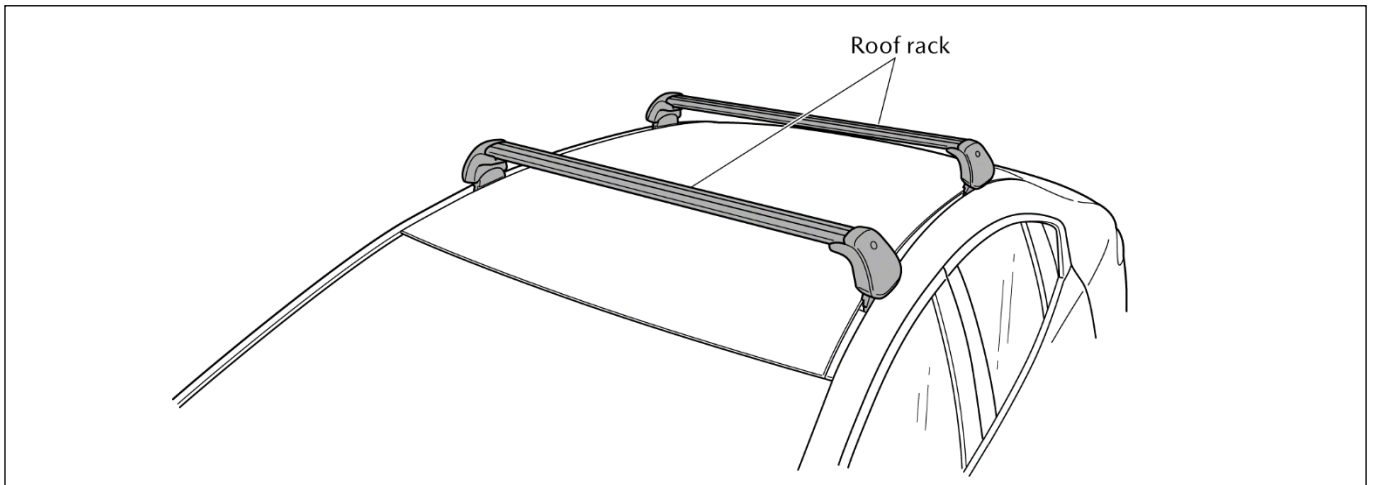

- Keep these instructions after installation. The instructions may be necessary for installing other optional parts or removal of this accessory.
- Should the vehicle or this accessory be resold, always leave these instructions with it for the next owner.

# 1. INSTALLATION VIEW



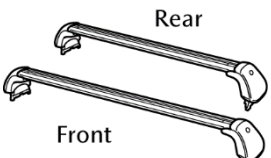

# 2. PARTS

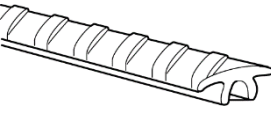
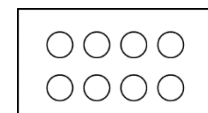
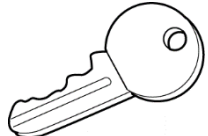
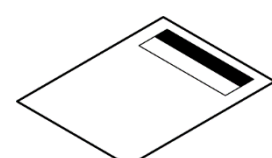
- Before installation, verify that the kit includes all the following parts and that they are free of dirt, scratches, or damage.

Part	Part name	Qty	Part	Part name	Qty
 <p>Rear Front</p>	Front crossbar (Long) Rear crossbar (short)	Each 1		Allen key (5mm)	1
	Wind noise prevention rubber	2		Protective film	1
	Key	2		Installation and user's instruction	1

## [Sold separately] Roof moulding

Part	Part name	Qty	Part	Part name	Qty
 <p>* There is an "R" marked on the underside of this roof moulding.</p>	Roof moulding (RH) • For sedan : BCYH 50 9H0A • For hatchback : BCYC 50 9H0	1	 <p>* There is an "L" marked on the underside of this roof moulding.</p>	Roof moulding (LH) • For sedan : BCYH 50 9L0A • For hatchback : BCYC 50 9L0	1

### 3. BEFORE INSTALLATION

#### REQUIRED TOOLS (Make sure they are at hand before starting work)

☆Remover tool

#### WARNING

Before performing any work, park the vehicle on level ground, apply the parking brake securely, and then block the wheels. If the vehicle moves while performing work, it may cause injury.

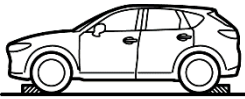

#### CAUTION

Using improper tools may cause damage and or broken parts. Use the correct tool for the installation.

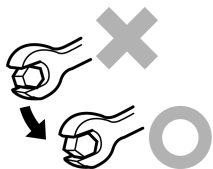

Place the removed parts and kit accessories on a protective sheet to prevent scratches.

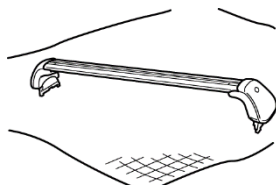

Installation and removal work should always be carried out by two people in order to avoid damage to parts.



#### Advice

Refer to the Workshop Manual for removal and installation of applicable vehicle parts.



## 4. VEHICLE PARTS REMOVAL

- The illustration shows the left side of the vehicle. Follow the same procedure when installing to the right side.

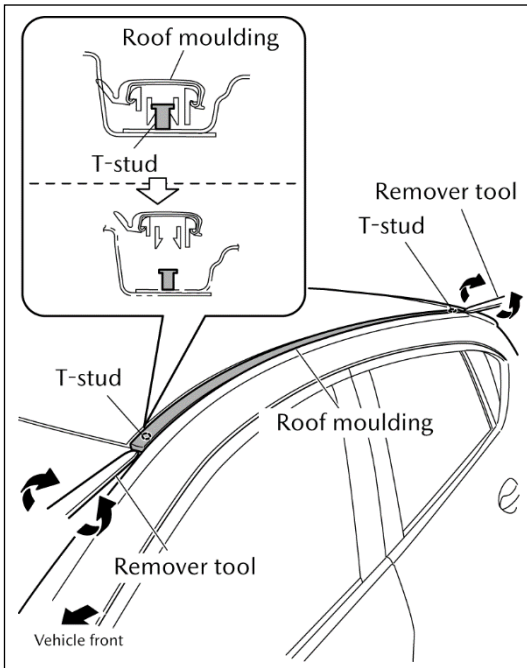

### Roof moulding removal

1. Insert the remover tool at the position shown in the illustration.
2. Move the remover tool in the direction of the arrow shown in the illustration to disengage the T studs from the rear moulding. (2 places at front and rear)

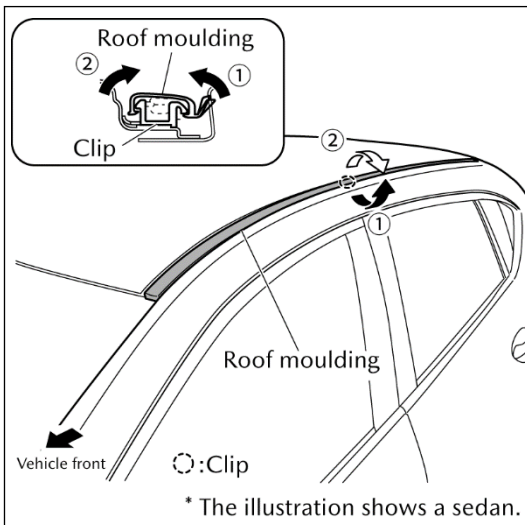

3. Disengage the clip of the roof moulding, starting from the outside (①), and then the inside (②).

\* Sedan: Clip (1 place)

\* Hatchback: Clip (2 place)

- The removed roof moulding will not be reused.

## 5. INSTALLATION TO THE VEHICLE

- The illustration shows the left side of the vehicle. Follow the same procedure when installing to the right side.

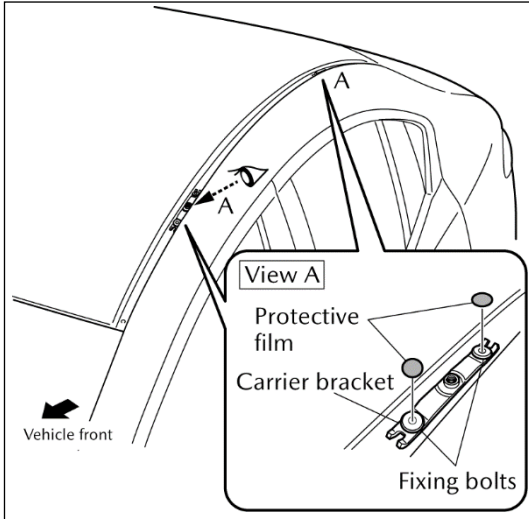

### Protective film attachment

1. Attach the protective film to the tops of the fixing bolts of the carrier bracket. (2 places)

- Before attaching the protective film, use a cloth to wipe the attachment areas so that they are clean.

2. Carry out at the rear in the same way.

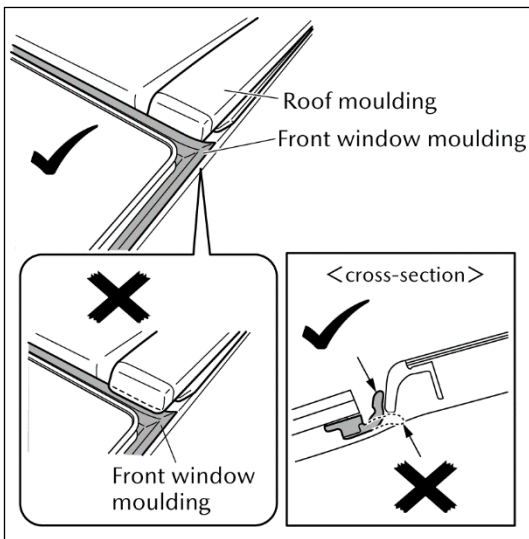

### Roof moulding installation

1. Install the roof moulding (sold separately) by following the "Roof moulding removal" procedure in reverse.
2. Adjust the front and rear ends of the roof moulding so that they are underneath the window moulding as shown in the illustration at left.

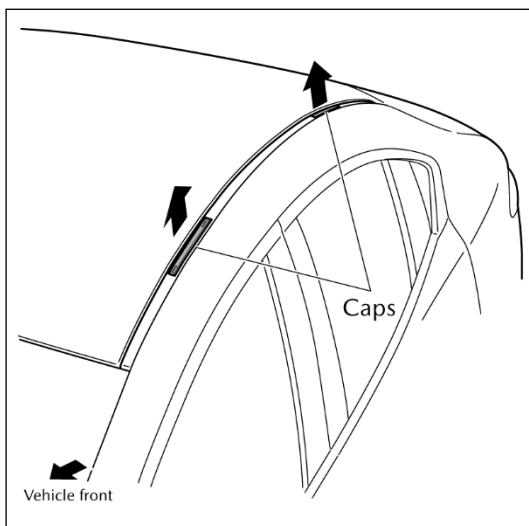

3. Slide the caps of the roof moulding to remove them. (2 places)

- Save caps for re-use in case crossbars are ever removed.

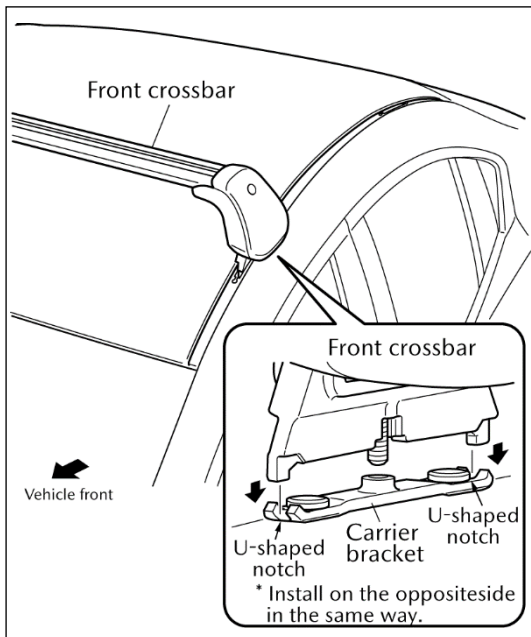

## Crossbar installation

1. Provisionally set the front crossbar in between the U-shaped notches in the carrier bracket.

- Be careful not to install the front crossbar the wrong way around.

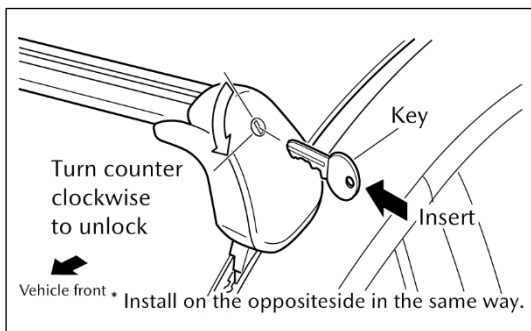
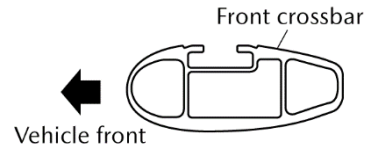

2. Insert the key into the key slot in the front crossbar and unlock it.

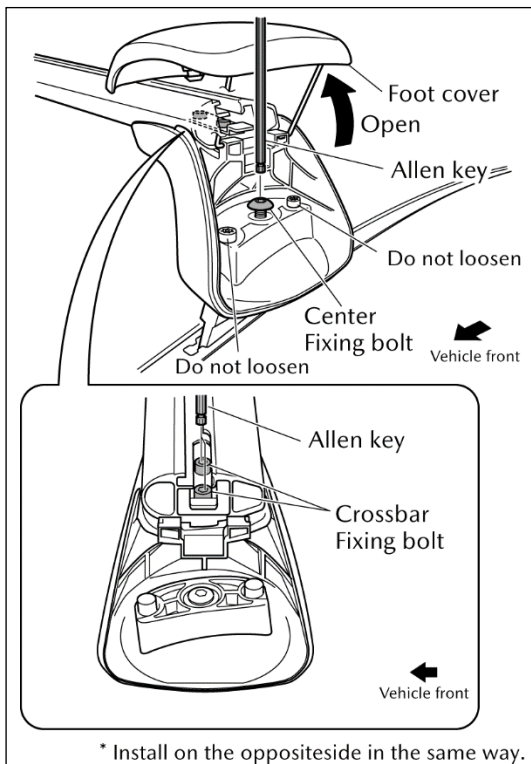

3. Open the left and right foot covers of the front crossbar. Make fine adjustments to the position of the front crossbar, and then provisionally tighten the center fixing bolts (1 each at left and right) by hand. If the center fixing bolts are not tightened, loosen the crossbar fixing bolts to adjust the position.
4. After checking that the left and right fixing bolts are inserted straight, use the Allen key to fully tighten center and crossbar fixing bolts. (3places).

**Center and Crossbar fixing bolt tightening torque: (6.0 N·m)**

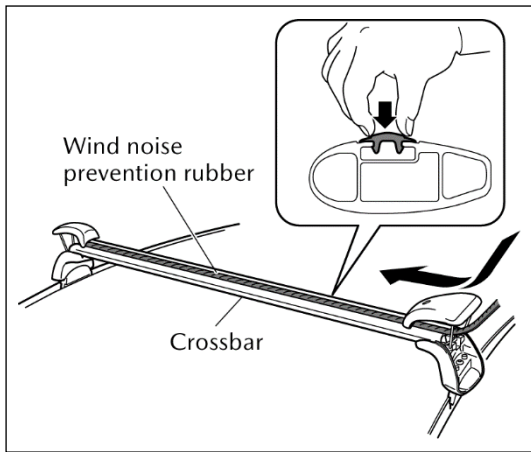

### Wind noise prevention rubber installation

1. Insert the end of the wind noise prevention rubber into the installation notch in the front crossbar, and then slide the rubber along the front crossbar while pressing down on it.

- If you wet the crossbar with water beforehand, the wind noise prevention rubber can be installed more smoothly.

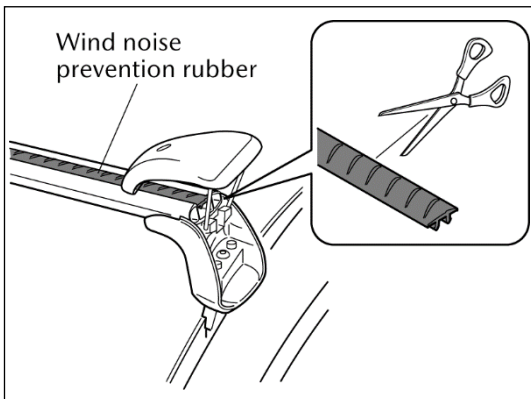
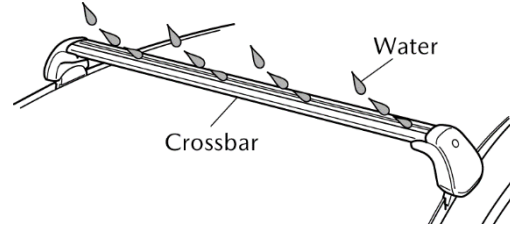

2. Cut the wind noise prevention rubber to the same length as the crossbar.
3. Close the foot covers to lock them. (Turn to the right)
4. Install the rear crossbar to the vehicle in the same way.

## 6. CHECKING AFTER INSTALLATION

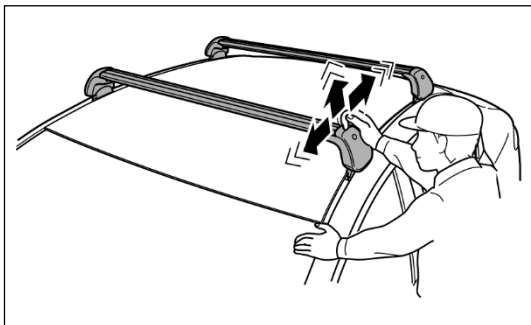

Shake the roof rack up, down and sideways to check that it is installed securely with no play or looseness.

If the roof rack moves at this time, re-check the installation positions and installation method and the tightness of all parts according to the procedures in this manual to make sure that everything is installed securely.

## 7. TO THE CUSTOMER

Be sure to read the following points carefully and be sure to follow them closely in order to use this product correctly.

**Remove the roof rack when not using it.**

### 1. Points to note and checks before driving

#### **⚠ WARNING**

- The roof rack is not designed to directly carry the weight of the load being carried, so purchase separate attachments which match the loads to be carried, and install them to the roof rack.
- The maximum laden weight is 75 kg (including roof rack (5.5 kg) and attachment). Do not overload the roof rack.
- The roof rack may become loosened slightly during initial use, so be sure to tighten it. Periodically check the roof rack for looseness. (As a guide, check after each period of driving a distance of 1000 km.
- If loading with long objects such as skis or masts, make sure that they do not cause any obstruction when opening the back door.

## 2. Points to note and checks during driving

### WARNING

- Avoid any sudden turning or sudden braking when driving while the carrier is installed, otherwise the load being carried might fall off or become damaged.
- Changes in the road conditions (in particular winding roads and roads with poor surfaces) and the weather conditions (such as strong crosswinds or headwinds, or rain, snow or fog) may cause dramatic differences in vehicle handling characteristics between when the carrier is installed and when it is not installed. Be sure to reduce speed as appropriate in such situations.
- When driving in places with height limits such as tunnels and multistory car parks when the carrier is installed, check that the overall height of the laden vehicle is within the total height restrictions.

## 3. Points to note during car washing

- Do not use an automatic car wash to wash the vehicle while the roof rack is still installed, otherwise the roof rack may become damaged or it may damage the roof of the vehicle. Be sure to remove the roof rack before using an automatic car wash to wash the vehicle.
- In addition, if the roof rack has not been removed, wash the vehicle by hand.

## 4. Removal and storage

### ① Removal

- (1) Remove all of the load being carried from the attachments.
- (2) Remove the attachments. For details on removing the attachments, refer to the separate instructions for the attachment. Open the foot covers and loosen the fixing bolts by following the procedure in "5. INSTALLATION TO THE VEHICLE" in reverse.
- (3) Remove the roof rack from the vehicle.

### ② Storage

- When storing the roof rack, clean it thoroughly and store it in a place which is free from moisture.
- Be very careful not to lose any of the accessories or these instructions.

### ③ Making a note of the key number

- Make a separate note of the key number.
- This number will be needed if the key ever becomes lost.

### ④ Re-installation

- When re-installing this product, check that all component parts are present and that they are not damaged, and then install by following the procedure in these instructions.

**If you have any questions regarding this product, please contact the place of purchase.**