

GENUINE USB Cable set

INSTALLATION INSTRUCTIONS

Thank you for purchasing a Genuine Mazda Accessory.

Before removal and installation, please thoroughly read these instructions.

Please read the contents of this booklet in order to properly install and use the USB cable set. Your safety depends on it.

Keep these instructions with your vehicle records for future reference.



- There are several **⚠ WARNING** and **⚠ CAUTION** sections in this booklet concerning safety when installing or removing the USB cable set. Always read and follow them in order to prevent injuries, accidents, and possible damage to the vehicle.

⚠ WARNING: Indicates a situation in which serious injury or death could result if the warning is ignored.

⚠ CAUTION: Indicates a situation in which bodily injury or damage to the vehicle could result if the caution is ignored.

- For areas indicating the tightening torque in this instruction manual, tighten to the specified torque using a torque wrench. For areas in which the tightening torque is indicated inside parentheses (), the tightening torque is indicated as a reference value, however tightening using a torque wrench is not necessary.
- Do not modify the USB cable set.
- Do not install the USB cable set in any way other than described in the following instructions.
- If you have any questions about the use of the accessory, ask your Mazda dealer for proper advice before using it.
- Mazda and its suppliers are not responsible for injuries, accidents, and damage to persons and property that arise from the failure of the dealer or installer to follow these instructions.
- To ensure safety and reliability of the work, installation, removal and disposal work must be carried out by an Authorized Mazda Dealership.
- Be careful not to lose removed parts, and be sure that they are kept free from scratches, grease or other dirt.

PART NAME: USB cable set

PART NUMBER: C922 V6 605

VEHICLE: MAZDA CX-9

NOTE: For Vehicles with
MZD Connect only

NOTE

To the dealer

- Please turn over these instructions to the customer after installation.

To the customer

- Keep these instructions after installation. The instructions may be necessary for installing other optional parts or removal of this accessory.
- Should the vehicle or this accessory be resold, always leave these instructions with it for the next owner.

▲ The firmware **MUST BE UPDATED FIRST** before beginning the installation.





If an older version of the CMU software is being used, the CarPlay/Android Auto-compatible USB hub may not be recognized.

The software must be v70.00.21 or later. If not be sure to update the software.

Once the CMU has been attached to the CarPlay/Android Auto-compatible USB hub, the software cannot be updated.

1. PARTS

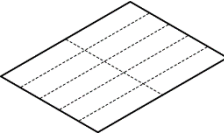
- Verify that the kit includes all the following parts and that the parts are not dirty, scratched, or damaged.

Part	Part name	Qty	Part	Part name	Qty
	USB cable (Gray/Blue-Brown)	1		USB cable (Gray/Green-Black)	1
	Tie wrap (L=200mm)	9		Sponge tape (100×30mm 10 sheets)	3
	Owner's manual Parts list	Each 1			

【Sold separately】 The following part is also necessary for installation.

HUB unit (Part No. TK78 66 9U0**)

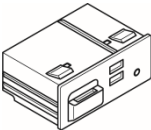
Part	Part name	Qty
	HUB unit	1

2. BEFORE INSTALLATION





REQUIRED TOOLS

- ☆Phillips screwdriver
- ☆Torque wrench
- ☆Socket wrench
- ☆Ratchet
- ☆Wrench or Glasses wrench
- ☆Fastener remover
- ☆Tape-wrapped flathead screwdriver
- ☆Nipper
- ☆Scissors
- ☆Scale



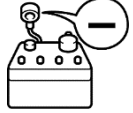
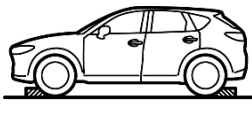

OTHER PREPARATIONS

- ☆Soft clean cloth
- ☆Mat
- ☆Protective tape
- ☆Protective gloves
- ☆IPA (Isopropyl alcohol)

⚠ WARNING

<p>When the negative battery is connected during operation, may cause electric shock or other personal injuries. Disconnect the negative cable before /installation.</p>	<p>Before performing any work, park the vehicle on level ground, apply the parking brake securely, and then block the wheels.</p>	<p>When connecting/dis- connecting connectors, grasp the connectors, not the wires. Otherwise a short, and an accident from poor contact or fire may occur.</p>	<p>Make sure the connector is securely pressed in until a click sound is heard. Otherwise, a fire or other accident may occur due to an open circuit or poor contact.</p>
			
<p>Secure the harness with the band (part included) so it doesn't dangle. If not, it may cause a short, accident, or fire.</p>	<p>Do not pull the harness with excessive force. Doing so can cause a breakage or a short-related accident, as well as an electrical short or fire.</p>		
			

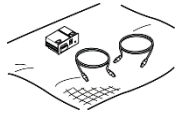
⚠ CAUTION

<p>Using improper tools may cause damage and/or broken parts. Use the correct tool for the job.</p>	<p>Wrap protective tape around screwdrivers and fastener remover tools to prevent scratching the vehicle.</p>	<p>Excessive length of tie wrap may interfere with other parts and cause damage.</p>	<p>Put the removed parts and the parts in the kit on the protective sheet to prevent scratches.</p>
			
<p>If there is dust, dirt or grease on the adhesion surface, the adhesive strength of the double-sided adhesive tape will splotch and adhesive power of the tape will be reduced. Wash and degrease the surface of the adhesion area before applying the double-sided adhesive tape. Be sure to wash interior and exterior parts using IPA (isopropyl alcohol).</p>			
			

ADVICE

<p>Refer to the Workshop Manual for removal and installation of vehicle parts.</p>

3. CONNECTION DIAGRAM

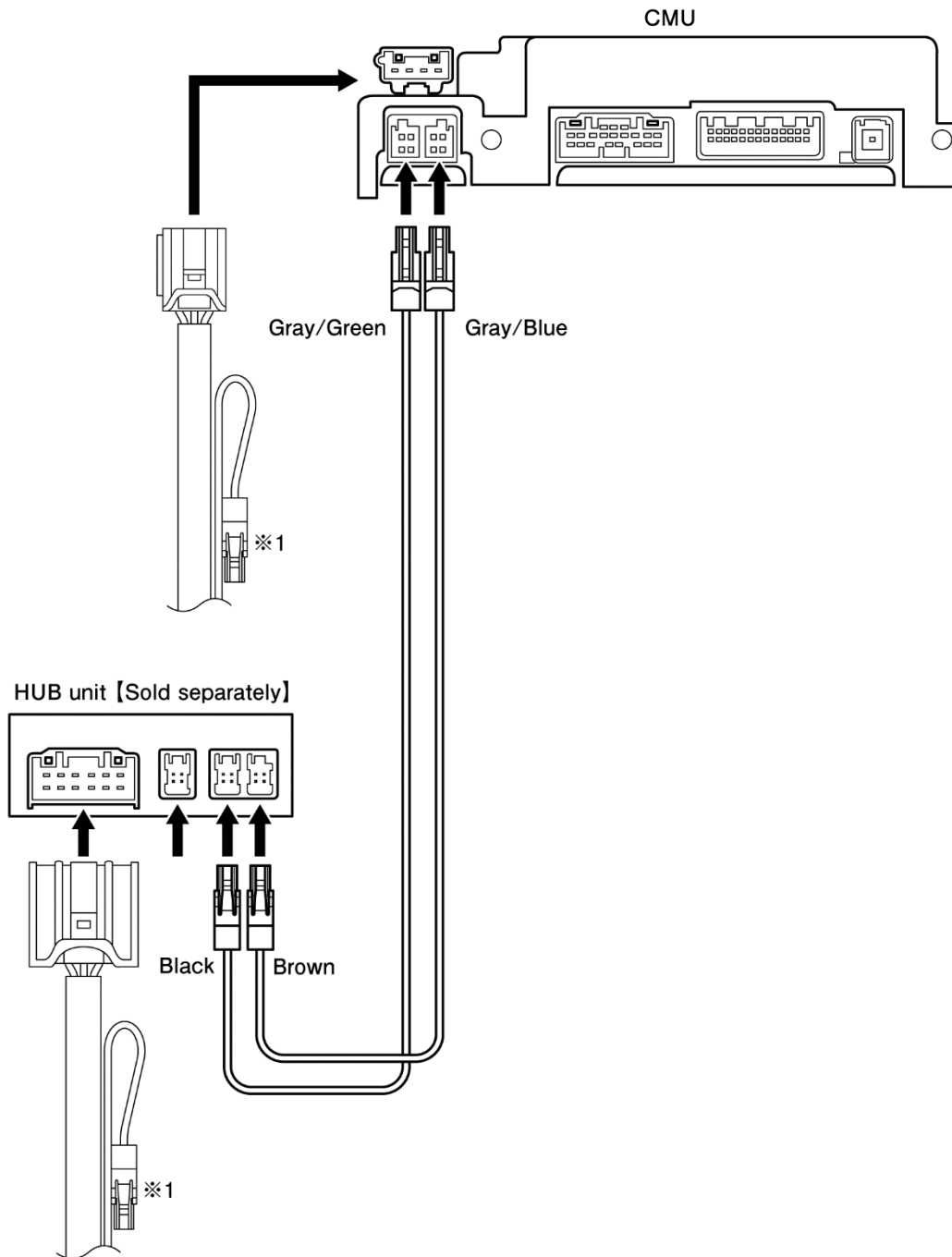

*1: To prevent noise, wrap the disconnected vehicle wiring harness connector with a piece of sponge tape (100 x 30 mm).
The diagram shows the case when there is a single vehicle wiring harness connector.
If there are two vehicle wiring harness connectors, carry out the same procedure for both connectors.

4. HUB UNIT INSTALLATION

1. Remove the Navigation SD Card from the SD Card slot (will be reused).
2. Remove the AUX unit from the vehicle, and then install the HUB unit (sold separately).
3. Install the Navigation SD Card into the new HUB unit.

⚠ CAUTION

- For details on removal and installation of parts, refer to the corresponding vehicle's Workshop manual.
- Parts that have been removed will not be reused.

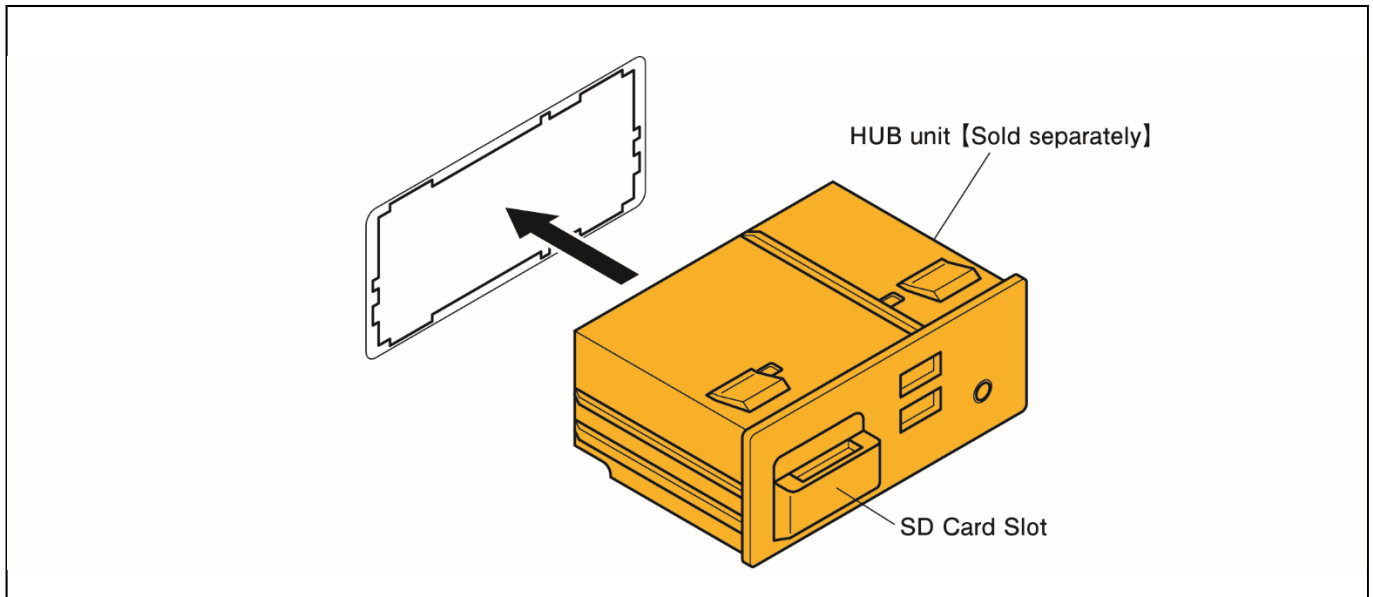

5. OPERATION CHECK

With the vehicle on, select APPLICATIONS from the Mazda Connect Home Screen and verify that the options for Apple CarPlay and Android Auto are shown.

While following the procedure given in the Workshop manual, use the diagnosis assist function of the connectivity master unit or the diagnostic device to check that no service codes are displayed.

MAZDA CX-9

■ LH

⚠ The firmware **MUST BE UPDATED FIRST** before beginning the installation.

If an older version of the CMU software is being used, the CarPlay/Android Auto-compatible USB hub may not be recognized.

The software must be v70.00.21 or later. If not be sure to update the software.

Once the CMU has been attached to the CarPlay/Android Auto-compatible USB hub, the software cannot be updated.

1. INSTALLATION VIEW

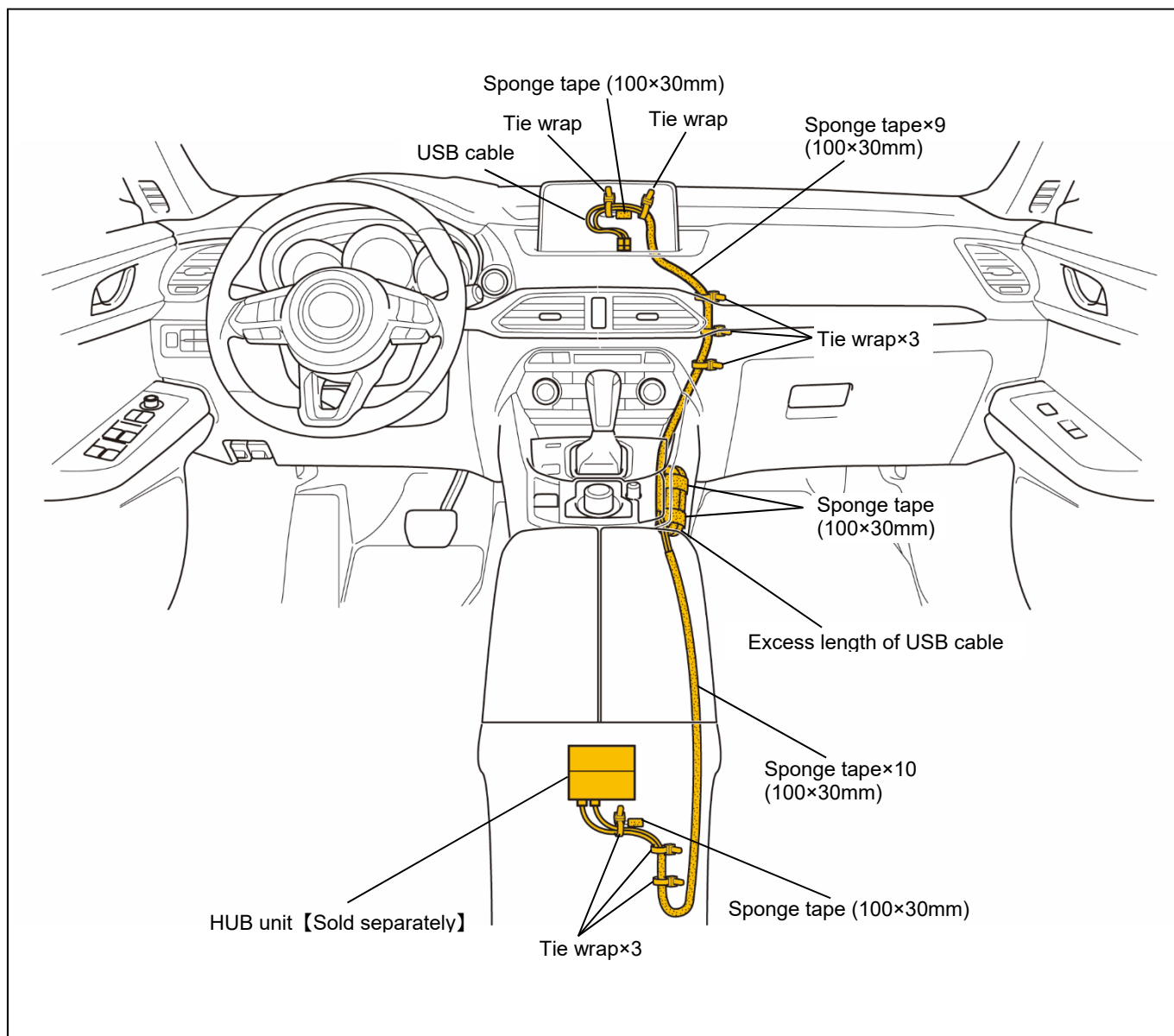

2. VEHICLE PART REMOVAL

Remove the following vehicle parts.

⚠ CAUTION

- The removed vehicle parts will be reused. Be careful not to get injured and not to lose any of the vehicle parts.
- The parts and methods of removal and installation may vary depending on the vehicle model. Refer to the corresponding Workshop manual for the vehicle being worked on.
If the procedures in the Workshop manual are not followed, accidents may result. In addition, it may cause problems with vehicle operation.

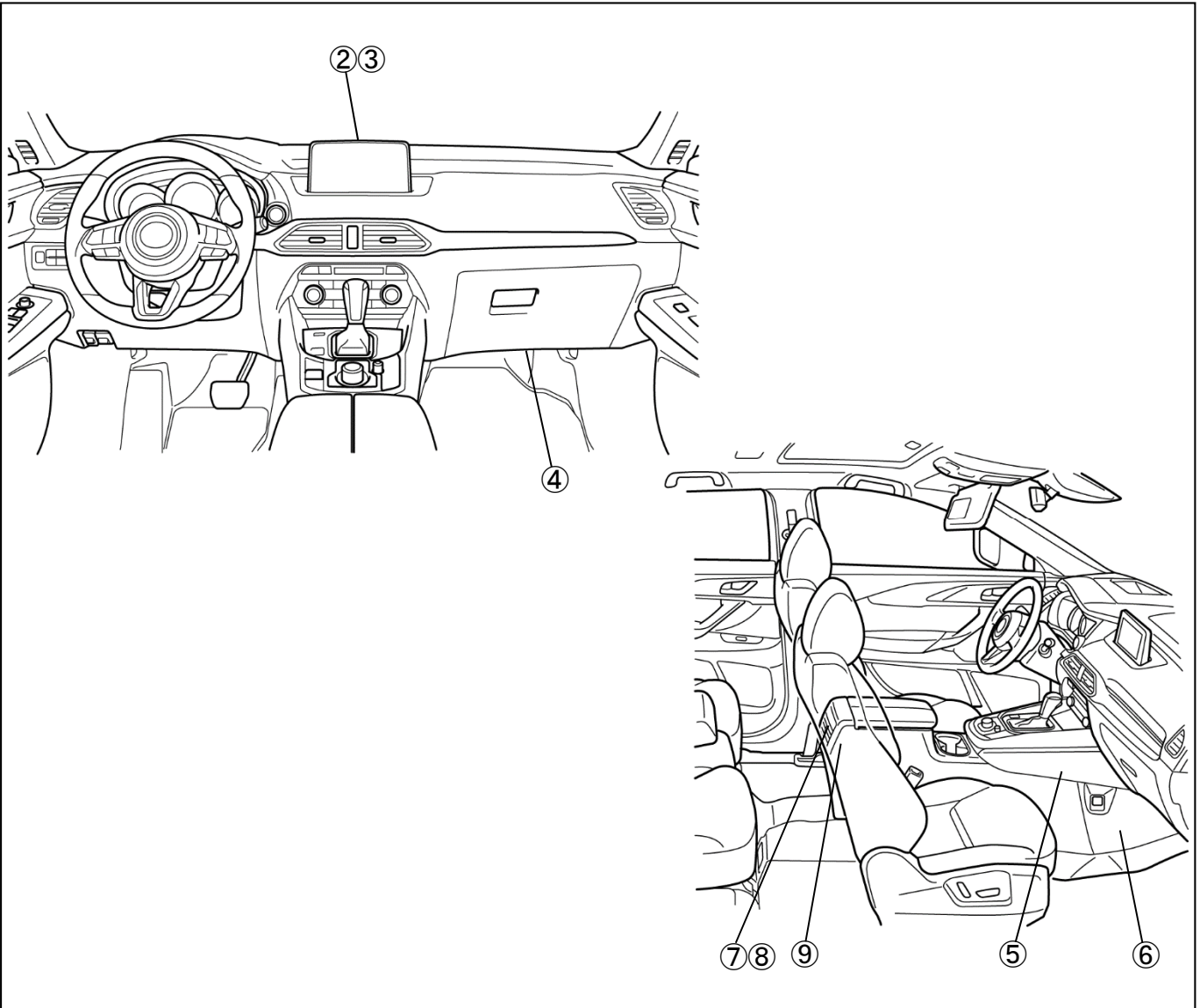

- ① Negative battery cable disconnection
- ② Center display
- ③ Connectivity master unit (CMU)
- ④ Glove compartment
- ⑤ Passenger-side console side panel
- ⑥ Passenger-side side wall
- ⑦ Rear console panel
- ⑧ Rear heater duct
- ⑨ Navigation SD Card (will be reused)

MAZDA CX-9

3. BEFORE INSTALLATION

■ Winding sponge tape

1. Wind sponge tape (100 mm x 30 mm) around the USB cable.

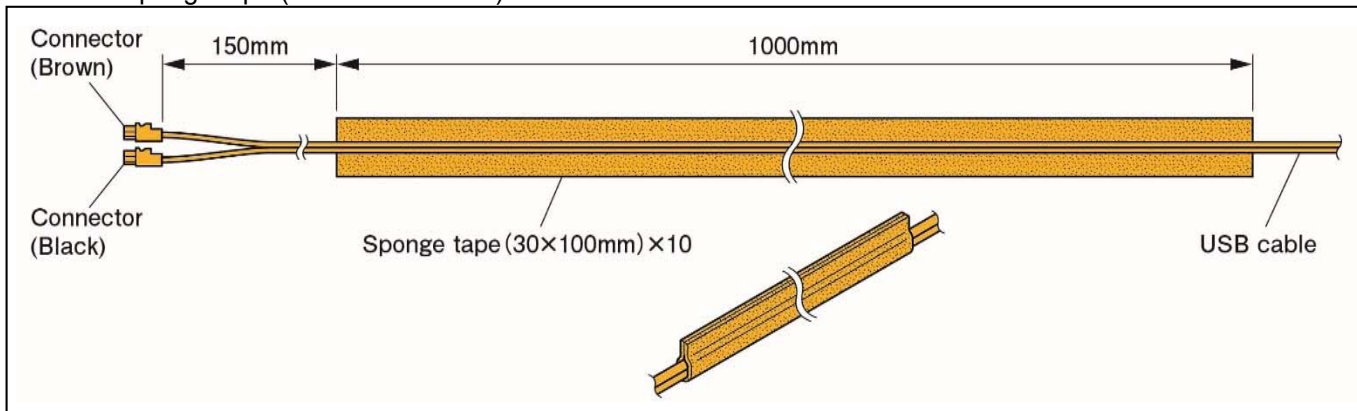

4. CABLE ROUTING

1. To prevent noise, wrap the disconnected vehicle wiring harness connector with a piece of sponge tape (100 x 30 mm).
2. Align the ends of the vehicle wiring harness connector and the USB cable connector.
3. Bend back the vehicle wiring harness connector, and then use a tie wrap to secure the vehicle wiring harness together with the USB cable.
4. Secure the USB cable to the vehicle wiring harness with a tie wrap.

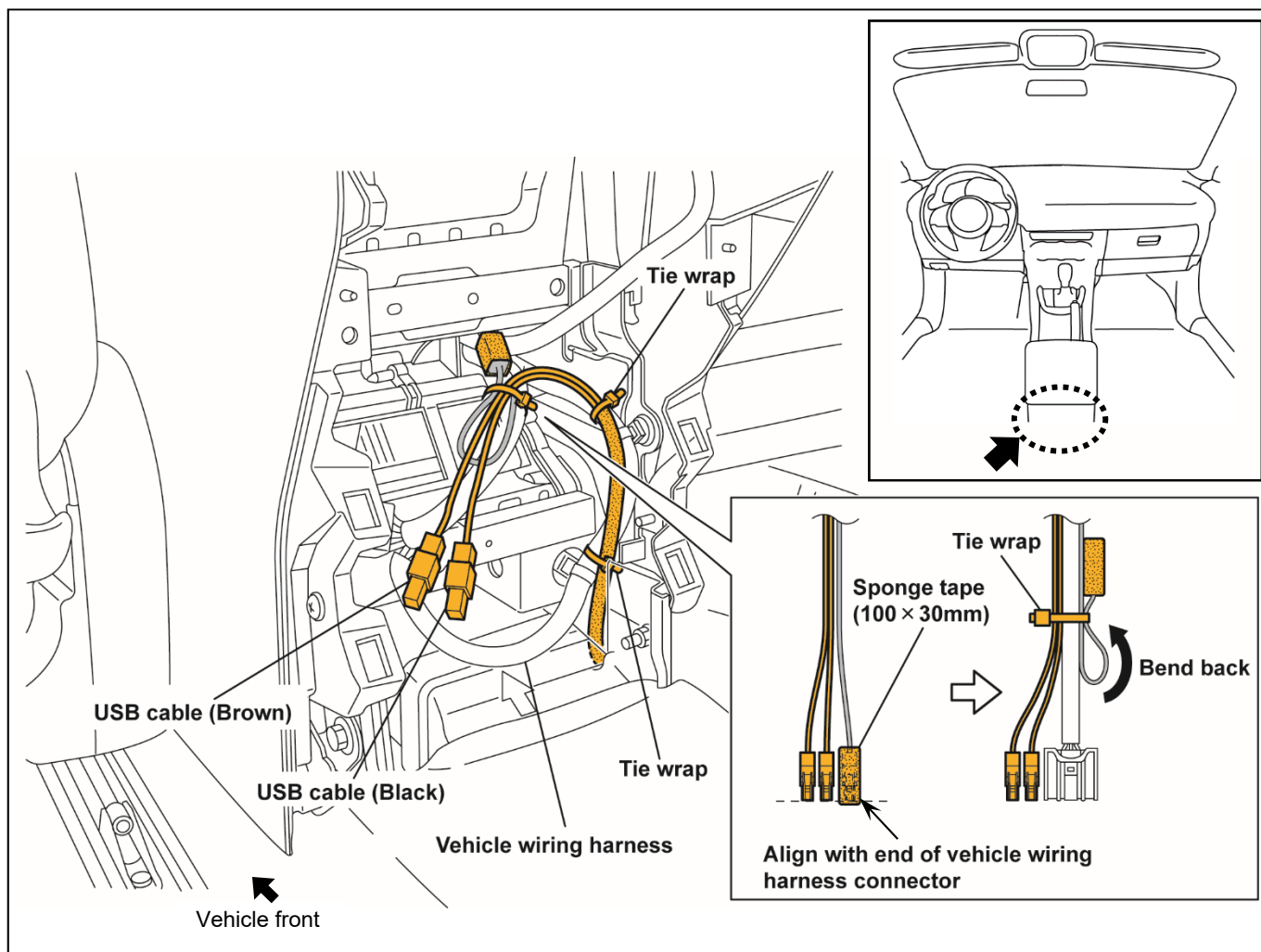

MAZDA CX-9

5. Slide the seat forward.
6. Route the USB cable under the seat rail.

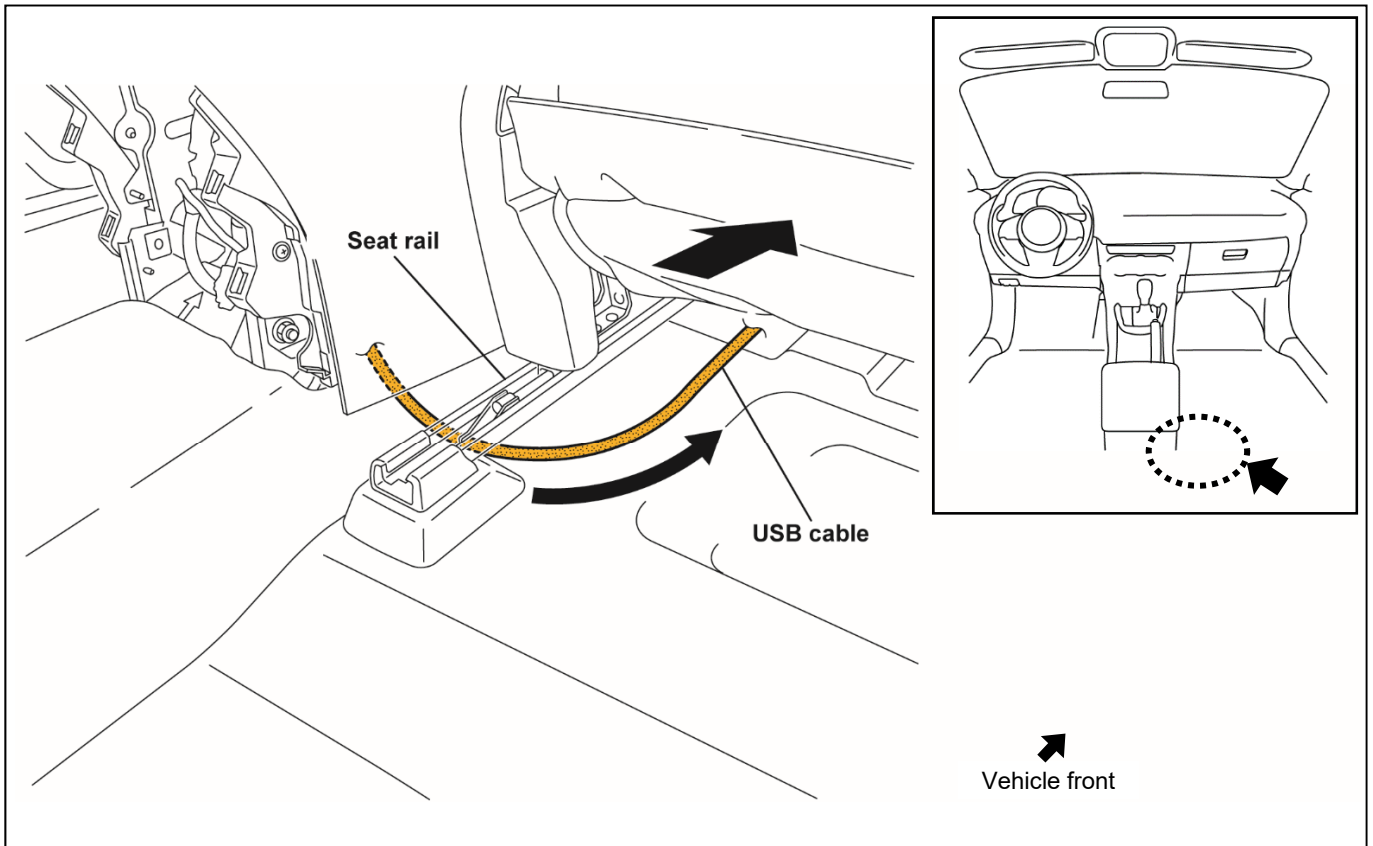

7. Slide the seat forward.
8. Bend the USB cable back, push it from under the seat rail into the rear console, and then route it around the bottom of the passenger's seat.

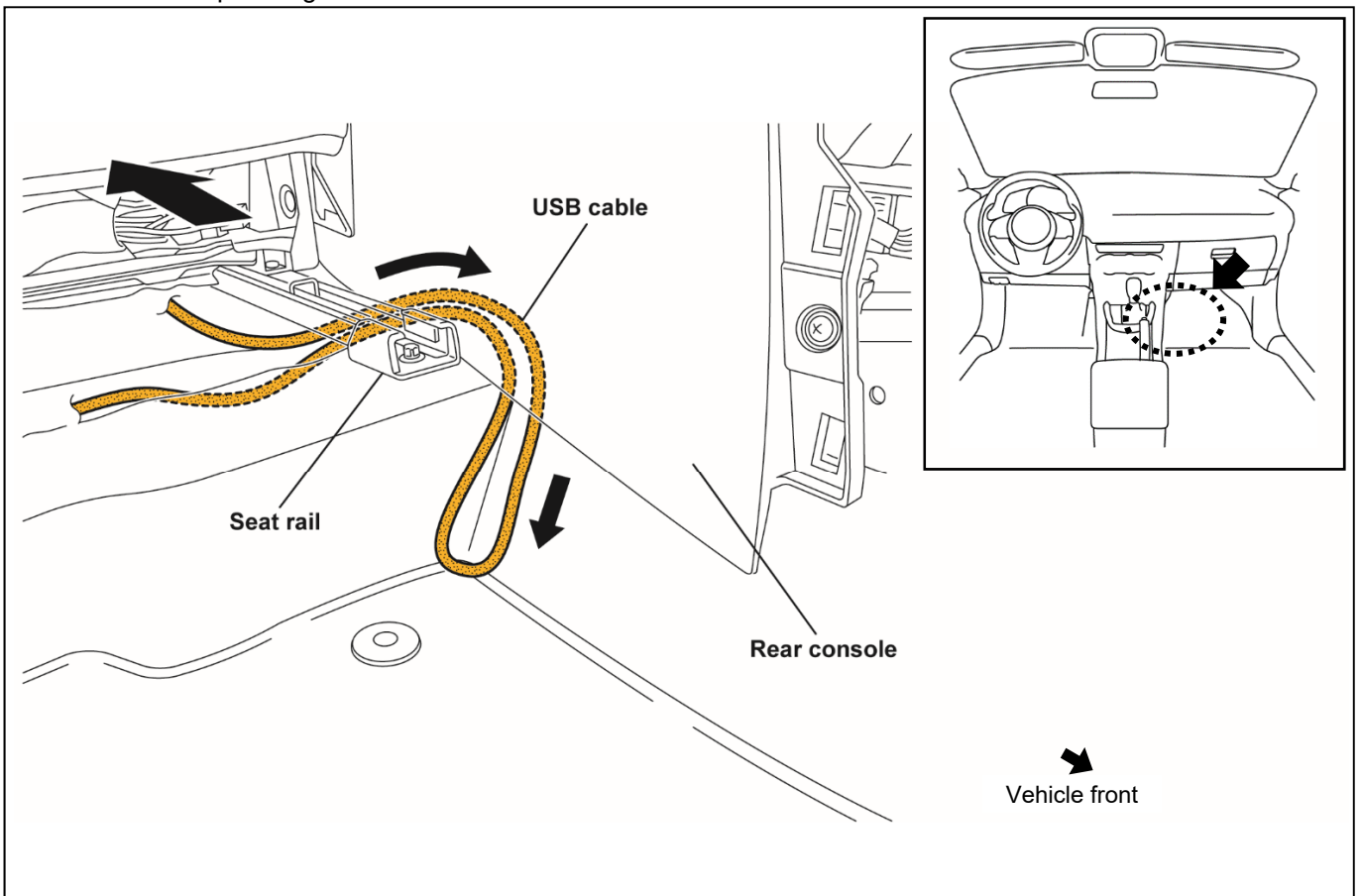

MAZDA CX-9

9. Push the USB cable into the rear console.

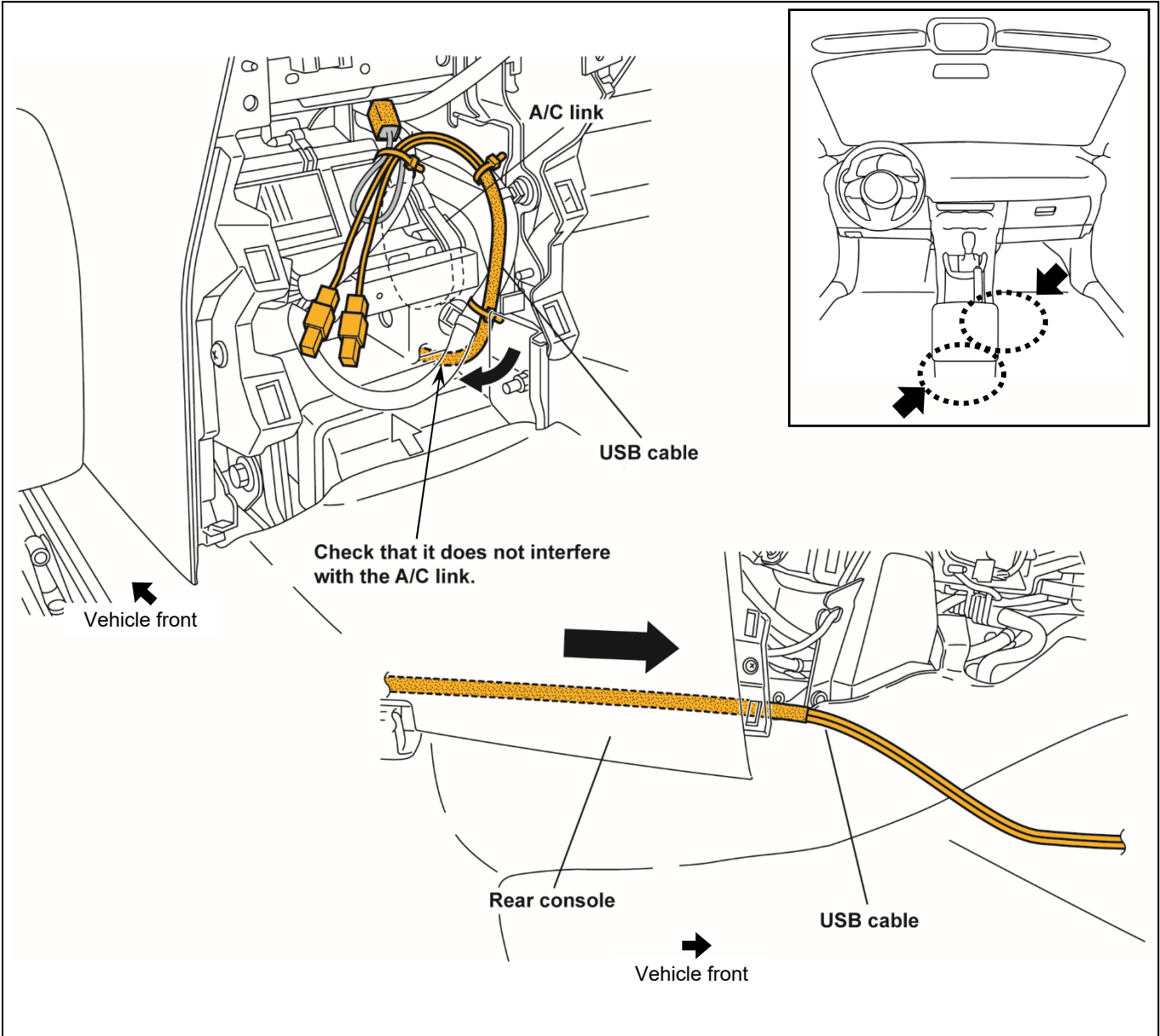

10. Wind sponge tape (100 mm x 30 mm) around the USB cable.

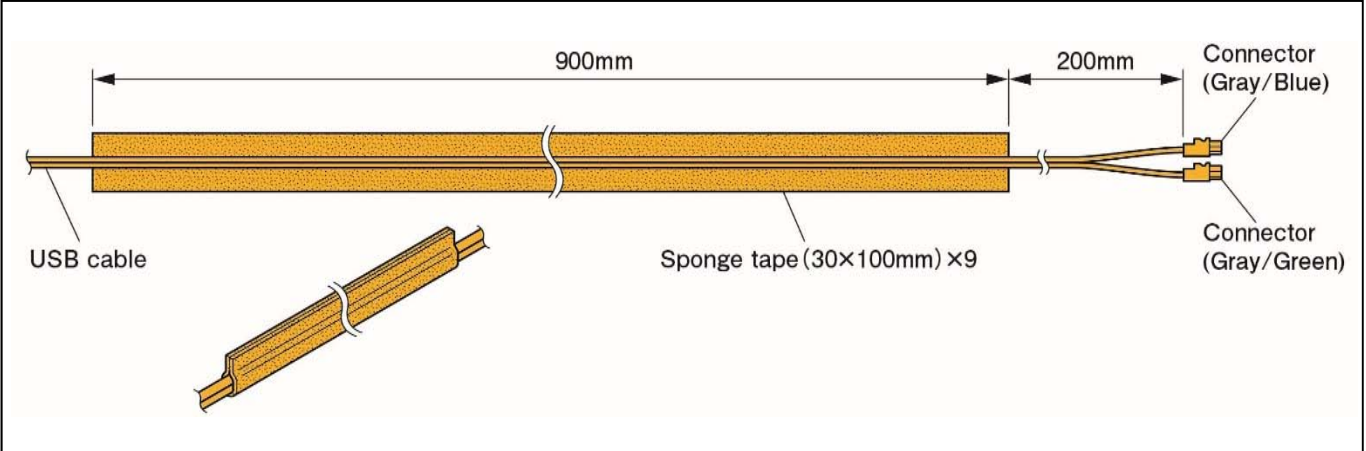

MAZDA CX-9

11. Route the USB cable to the underside of the center display.

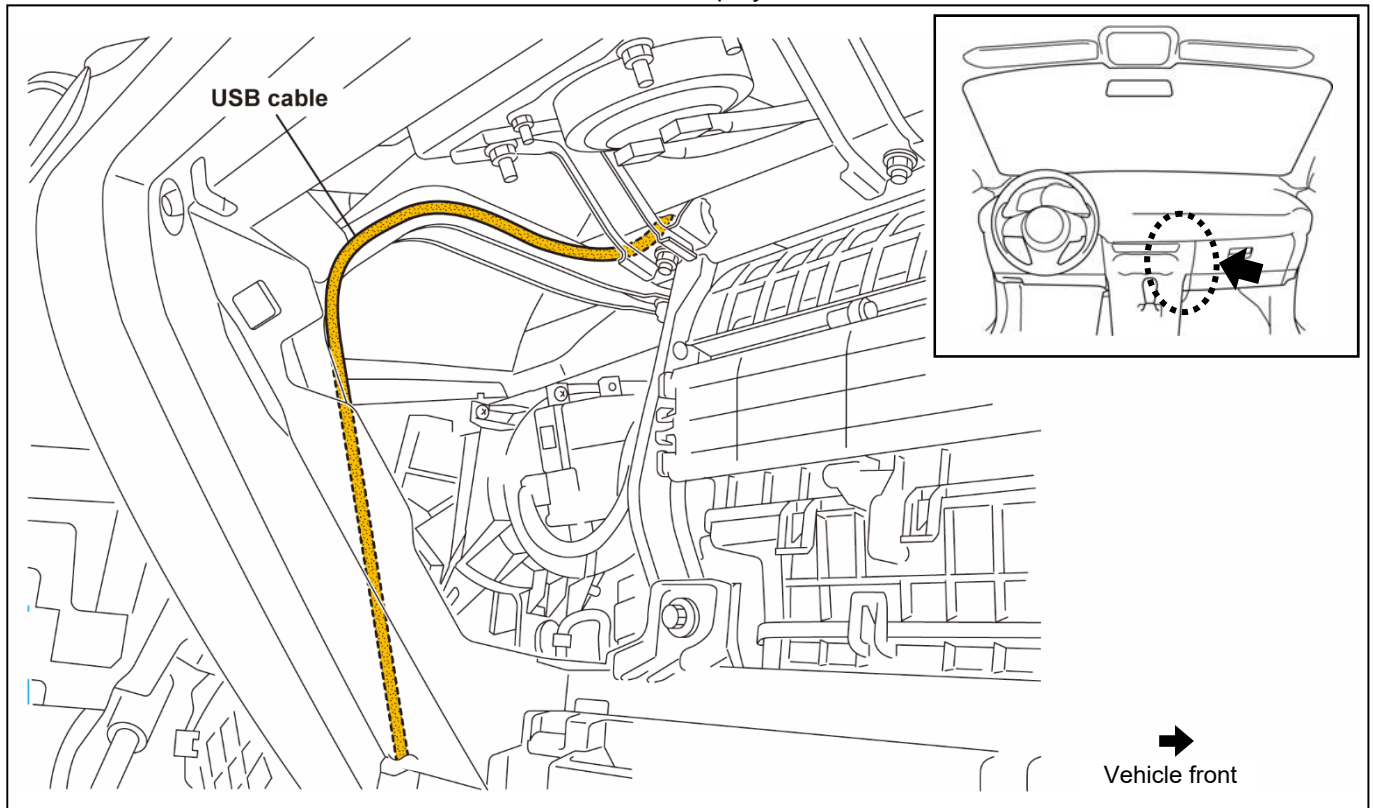

12. To prevent noise, wrap the disconnected vehicle wiring harness connector with a piece of sponge tape (100 x 30 mm).

13. Align the ends of the vehicle wiring harness connector and the USB cable connector.

14. Bend back the vehicle wiring harness connector, and then use a tie wrap to secure the vehicle wiring harness together with the USB cable.

15. Secure the USB cable to the vehicle wiring harness with a tie wrap.

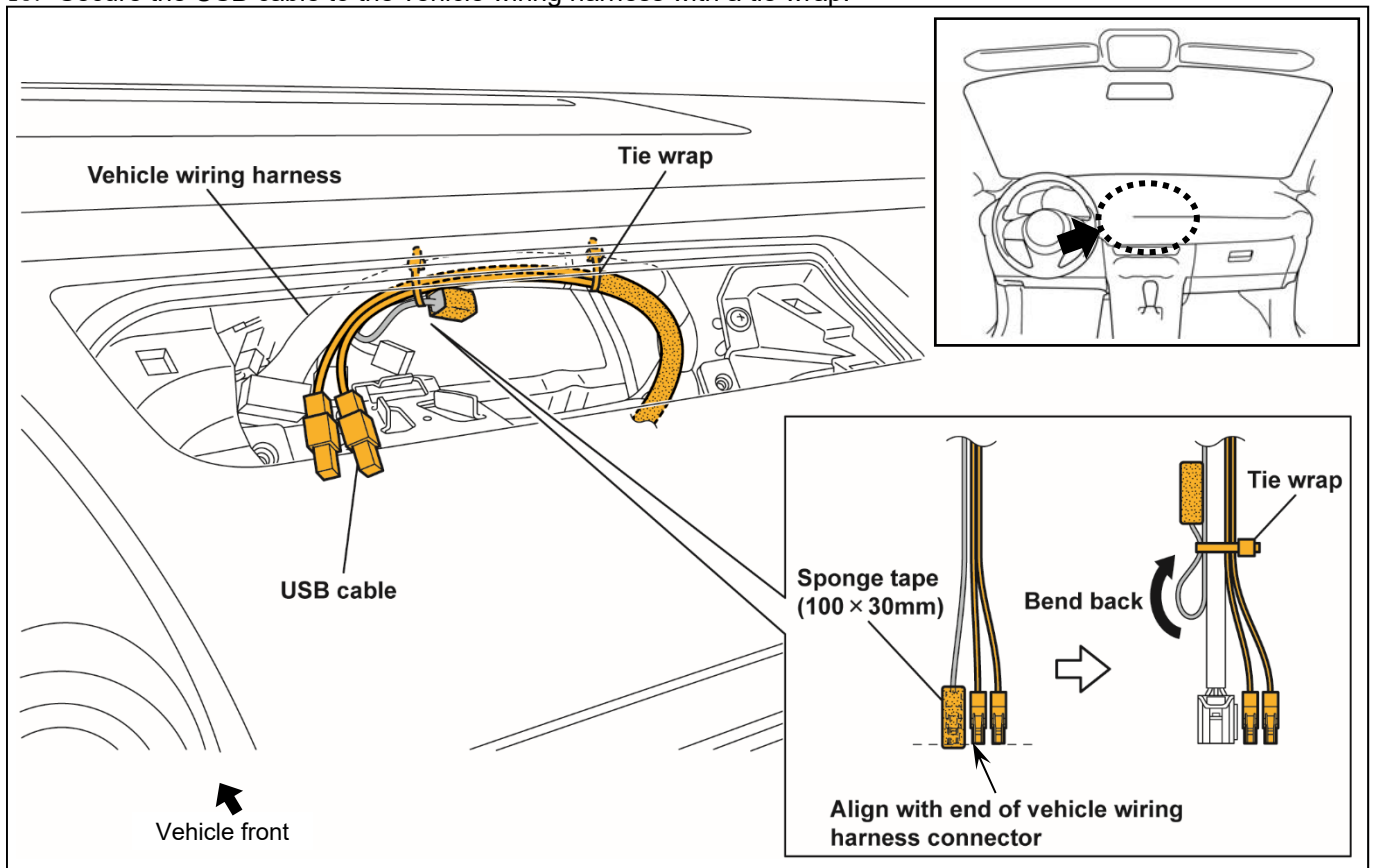

MAZDA CX-9

16. Secure the USB cable to the dashboard member with tie wraps.

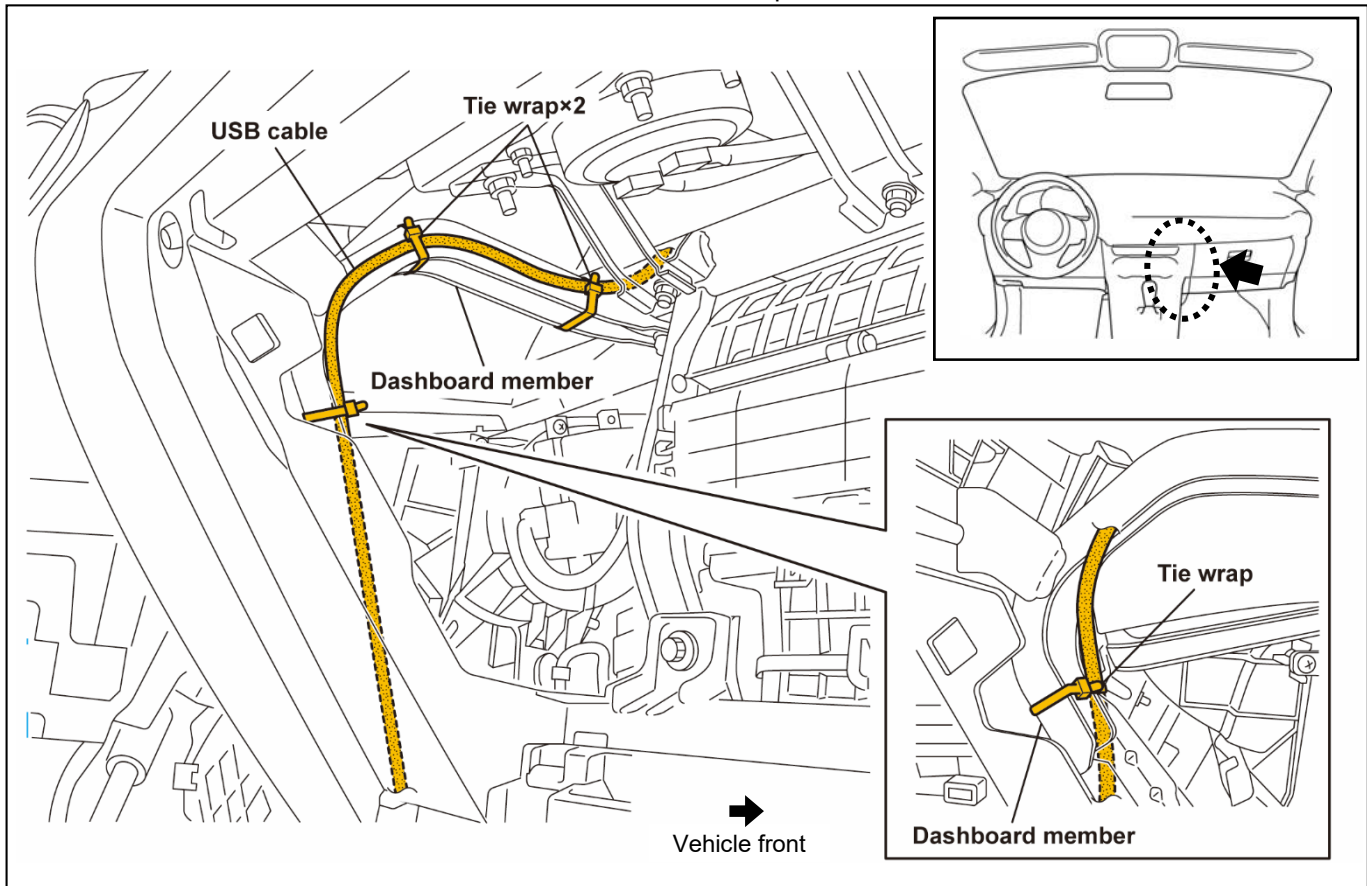

17. Bind the excess length of USB cable together and secure it with sponge tapes (100 x 30 mm).

18. Push the excess length of USB cable under the floor carpet.

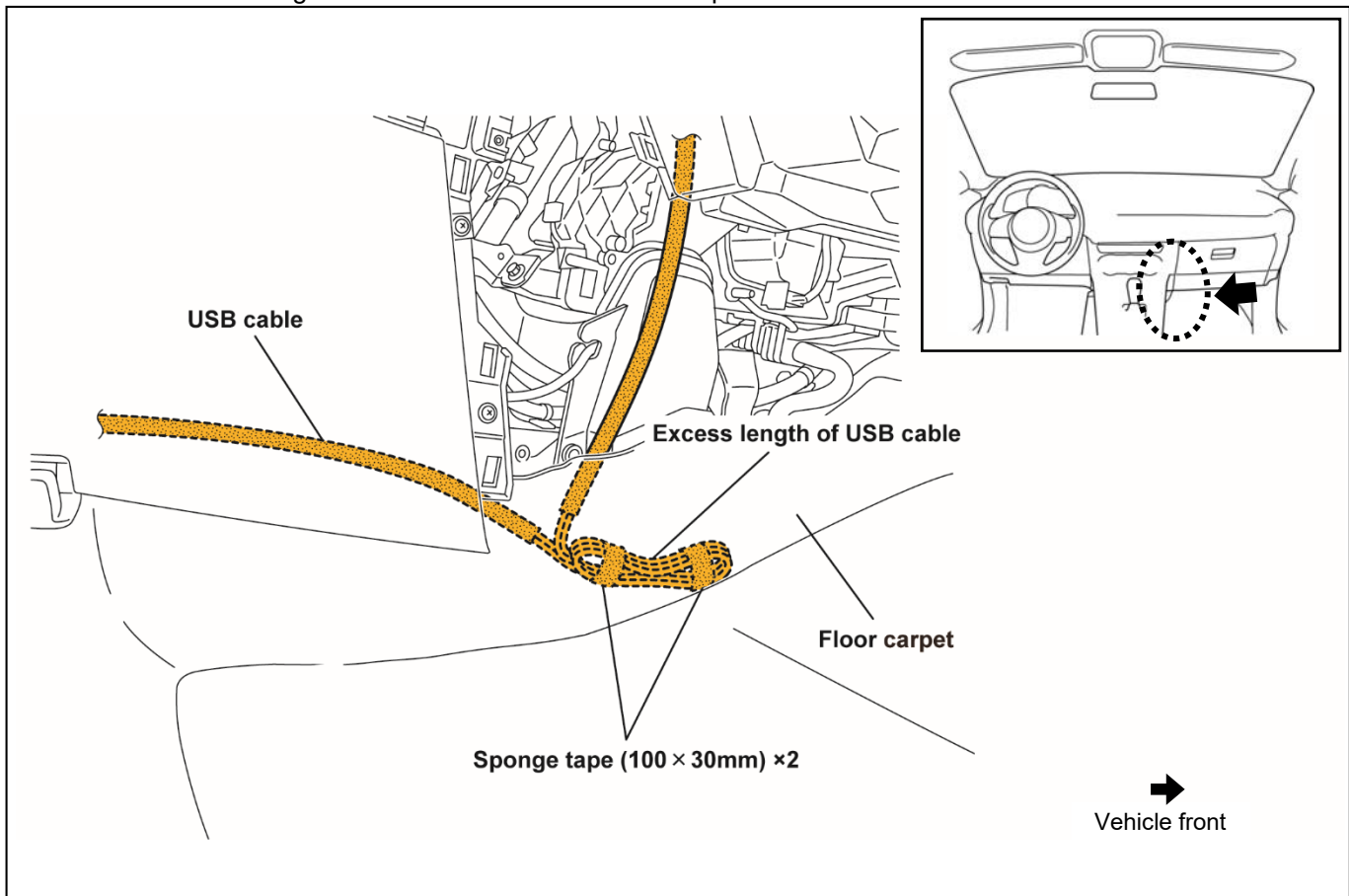

5. CAUTIONS WHEN RE-INSTALLING

1. Reinstall parts in the reverse order of the installation procedure in "VEHICLE PARTS REMOVAL".
(Refer to "3. CONNECTION DIAGRAM" on P.4 for details on connecting the USB cable connector.)
2. Refer to "Required servicing after disconnecting/connecting negative battery cable" in the vehicle workshop manual or the owner's manual to restore the vehicle functions.
3. Perform reinstallation and inspection of the vehicle parts.
Refer to "5. OPERATION CHECK" on P5 to carry out an operation check.
4. Check Navigation System operation.